

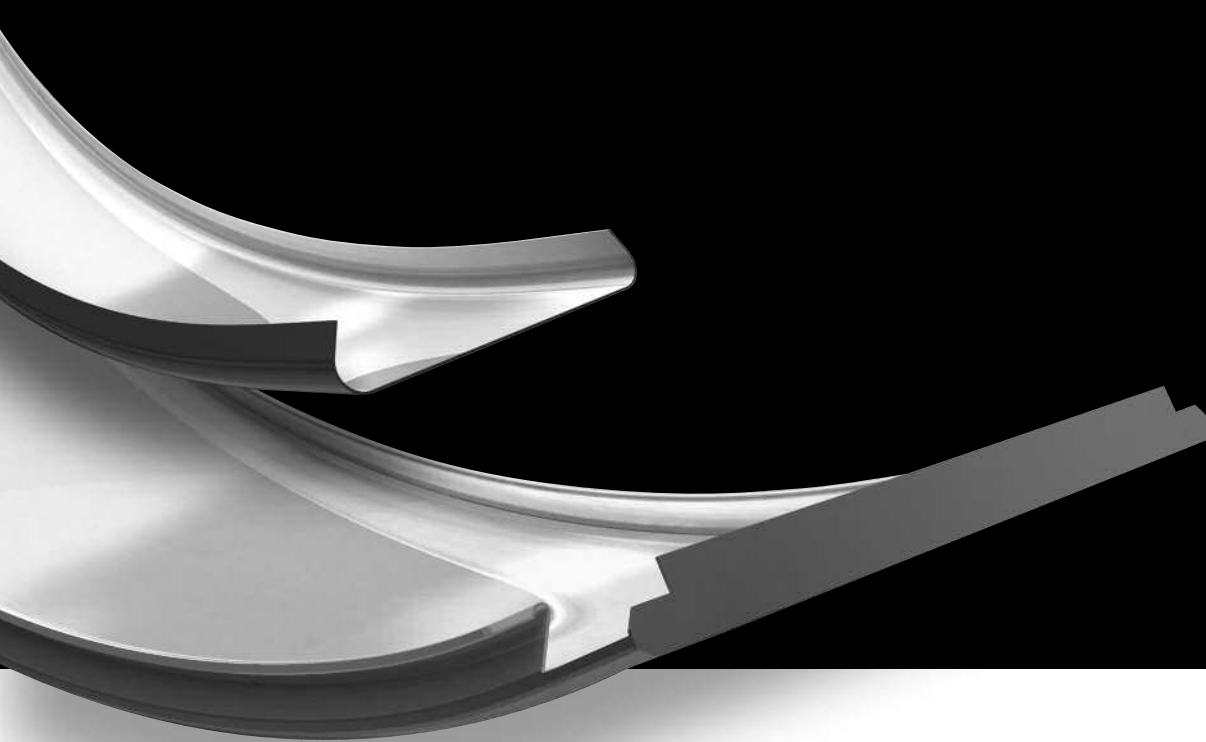

# Curved

Soft undulating shapes, curves, dramatic bulkheads - all design possibilities with Luxalon® Curved ceilings from Hunter Douglas. Explore your creativity and break boundaries - inside the curve.



**HunterDouglas**

CEILING

# Curved

## Soft, Skyward Sculpture



### **FLEXIBLE BY DESIGN**

Luxalon® Curved ceilings from Hunter Douglas add a twist to the traditional. Imagine concave, convex, and undulating forms that tempt a look upwards.

Create soft curves and sculpted shapes with Luxalon® Curved ceilings. 300C (300 mm wide) and 84R (84 mm wide) panels can curve up to 90 degrees, perfect for opening up public spaces. The Luxalon® curved carrier system helps to transform standard flat panels into dynamic ceiling designs.

The curve doesn't need to stop at the ceiling. Luxalon® Curved ceilings can partially - or completely - clad surrounding walls. Over 40 colours and finishes will ensure you create the perfect look for your project.

### **LONG LASTING, LOW MAINTENANCE**

Luxalon® Curved ceilings are manufactured from roll-formed aluminium coil. Finished with a polyester paint, these ceilings are durable and low maintenance. The coating is stove enamelled in a continuous coil coating process, which ensures uniform coating thickness and absolute adhesion.

For exterior applications, please request aluminium panels with our exclusive Luxacote® finish.

### **ALL-ACCESS PLENUM**

Most Luxalon® ceiling panels allow full plenum access, and can be easily demounted by hand.



Left : Metro Valencia, Estacion Santa Rosa  
 Location : Valencia, Venezuela  
 Product : Curved ceiling 300C

Luxalon® Curved ceilings give you freedom in design. Our ceiling systems are versatile, and create a variety of visual effects including unique radial and diagonal patterns and flowing curves.

#### PERFECTLY PERFORATED ACOUSTICS

Improve the acoustics in a space with ceiling panel perforations Ø1, 1.5 or 2 mm. Luxalon® perforated panels come with a special sound-absorbing non-woven tissue glued into the panel, further enhancing acoustical performance.

#### PROVEN FIRE PROTECTION

All Luxalon® metal suspended ceilings are fully tested for reaction to fire in official fire tests at Efectis, Rijswijk - an independent Dutch fire research institute. The ceilings are classified A2, s1, d0 according to EN 13501-1, and will therefore not contribute to possible fires. For more information visit [www.hunterdouglascontract.com](http://www.hunterdouglascontract.com)

<b>CONTENT</b>		<b>Page</b>
<b>300C Curved</b>		2
<b>84R Curved</b>		6
<b>Curved carrier</b>		9
<b>Material</b>	<b>Specifications</b>	10

## Innovative Products Make Innovative Projects



Production by  
 Hunter Douglas  
 Ceiling Center



**HunterDouglas**

# 300C Curved

## PANELS

The 300 mm wide panels (1) are made to measure and curved with a maximum standard length (L) of 6000 mm. Easy to fix, to the standard 300C carrier (2), one side of the panel is hung on the prongs of the carrier and then the other side is pressed in with an upward movement.

The panel carrier, which is black, and made of 1.0 mm thick galvanised steel or 0.95 mm thick aluminium, is provided with prongs that accommodate the panels. Integrated locking clips on the carrier can lock the panels, where required.

Carriers have a standard length of 5000 mm and are connected by the carrier splice (3). Panels are connected in length by applying a panel end connector (4) on cross sections of four panels (or two panels at the edge), still allowing easy demounting. A nonius hanger (5) and fixing pieces (6) are provided for suspension. Trimming curved and straight edges is possible - see our various edge trimming options for more information.

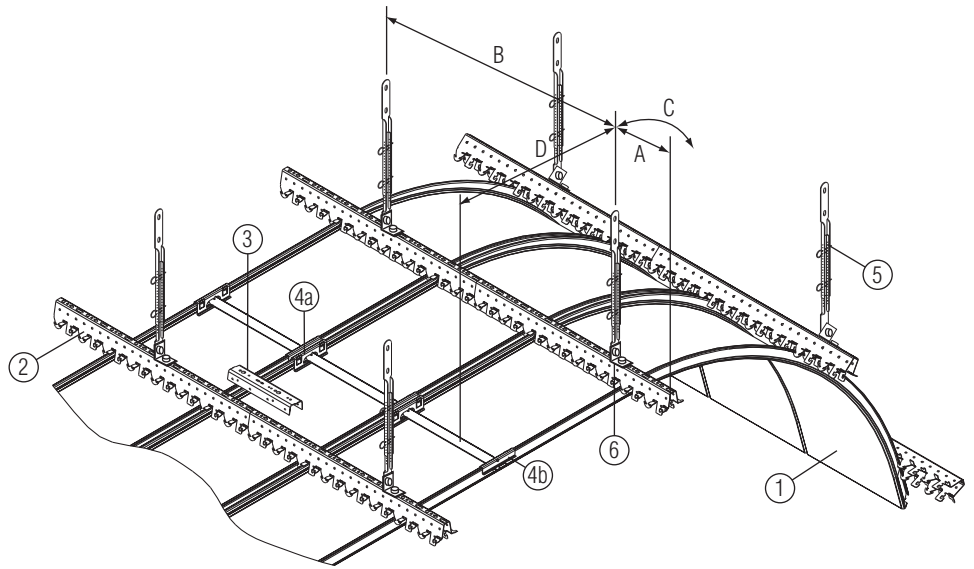

- 1 = curved 300C panel
- 2 = carrier
- 3 = carrier splice
- 4a = panel end connector
- 4b = panel end connector (cut in half)
- 5 = nonius hanger
- 6 = fixing piece (non HD)

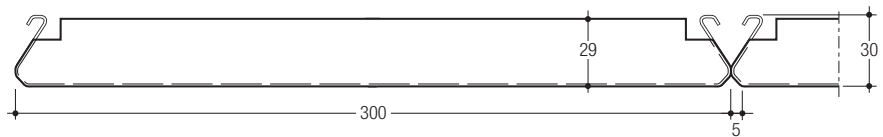

## MAXIMUM SPANS

\* Depending on the radius: min. span for radius is 1000 mm, max. span for radius > 50 meters.

Panel type	Carrier Span				Panel Span	
	Steel 1.0		Alu 0.95		C	D
	A	B*	A	B*		
Alu 0.7	300	1500-2000	300	1000-1450	750	400
Steel 0.6	300	1100-1600	N.A.	N.A.	750	400

## DIMENSIONS & WEIGHTS

Panels from 250-1000 mm and > 6000 mm are available on request.

\* Min. weight for flat panels; max. weight for radius 1000 mm

Panel	Width	Min. length	Max. length	Weight/m <sup>2</sup> *
Alu 0.7	300	1000	6000	2.9 - 4.5 kg
Steel 0.6				6.7 - 10.4 kg

## MATERIAL REQUIREMENT PER M<sup>2</sup>

The requirement depends on the execution of the curve and ceiling. For a flat ceiling the material requirement would be:

\* Depending on panel length from 1 to 6 meter.

\*\* Depending on radius and carrier type.

	Unit	300C Curved Panel system
Panels	lm	3.33
Carriers	lm	1.33
Carrier splices	pcs	0.27
Panel end connectors	pcs	0.55 - 3.33*
Nonius hangers	pcs	0.65 - 1.33**

# 300C Curved

## AVAILABLE CURVED PANEL TYPES

Minimum radius (R) for convex curves approx. 1000 mm, for concave curves approx. 1100 mm.

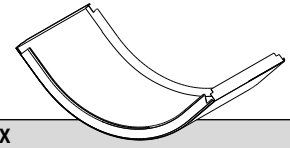
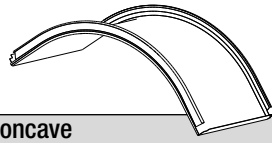

Type of Curve	Concave	Convex
Continuous curve		
Curve + straight end(s) C + D		

## APPEARANCE

\* Curved panels feature straight ends of min. 200 mm. Multiple panel curved ceilings with an approx. radius of 5000 mm or less not advisable.

I: Multiple panel curved ceilings:



II: Single panel curved ceilings:

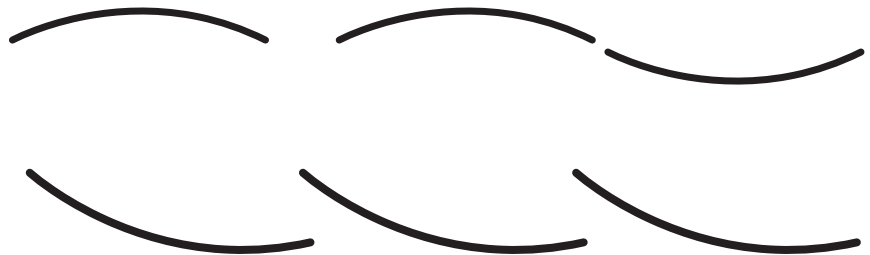

## VALUES

Legend	Min/Max Values
L = Length of straight panel	Lmin = 1 mtr (std)
	Lmax = 6 mtr (std)
C/D = Length of straight ends	C/Dmin = 200 mm
R = Radius	Rmin convex = 1000 mm
	Rmin concave = 1100 mm
$\alpha$ = Angle (alpha degrees)	$\alpha$ max = 90°

# 300C Curved

## STANDARD CONSTRUCTION DETAILS

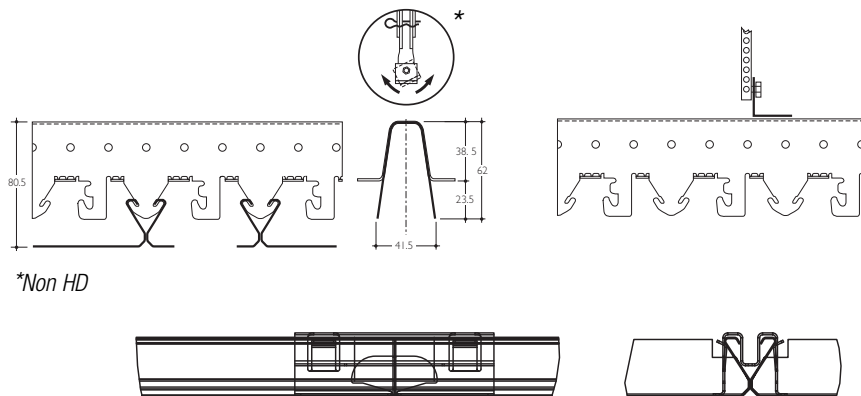

## EDGE TRIMMING OPTIONS

Note: all edge materials non-Luxalon®

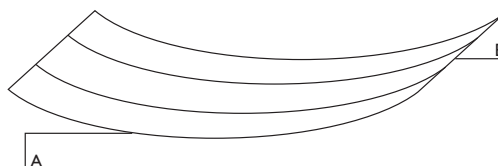

Edge Solutions	Curved edges	Straight edges
Wall-to-wall	<p>A1</p>	<p>B1</p>
Floating Floating (max. gap 1/2 M)	<p>A2</p>	<p>B2</p>
Floating Floating (max. gap 1/2 M)	<p>A3</p> <p>= max. 150 mm (1/2 M)</p>	<p>B3</p>
Floating/Island	<p>A4</p>	<p>B4</p>

## PLENUM ACCESSIBILITY

The 300C Carrier System allows for easy panel demounting. Each panel is fixed to the carrier, which allows each to be removed individually. Use a special shoe-horn shaped tool to remove the panels (available on request).

Apply panel end connectors at cross sections between four panels (or at edges of two panels) to keep the panels aligned.

# Acoustics 300C Curved

## ACOUSTIC PERFORMANCE

To improve acoustic performance, the Luxalon® 300C Wide Panel Ceilings can be perforated with a  $\varnothing$  of 1.5 or 2.0 mm (open area of 15% and 23%). A sound-absorbing non-woven tissue comes standard with perforated panels for enhanced acoustical performance. To further increase acoustic absorption, consider the ceiling radius: an increase in material surface quantity can result in up to 55% enhancement of absorption surface.

## PERFORATION OPTIONS

300C Carrier panels are available in 2 standard perforation patterns:

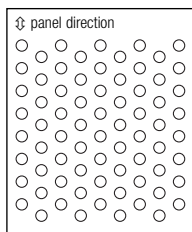

$\varnothing$  1.5 mm  
23% open area  
 $\Delta$  3 mm

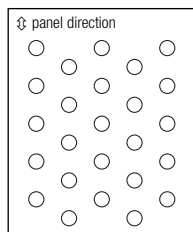

$\varnothing$  2.0 mm  
15% open area  
 $\Delta$  5 mm

## 300C

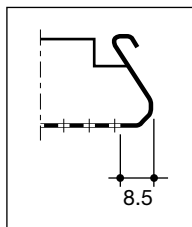

*Note: Panels have a nominal plain border of 8.5 mm along the longitude in order to assure maximum flatness and product stability.*

## SOUND ABSORPTION DATA 300C (straight 300C panel)

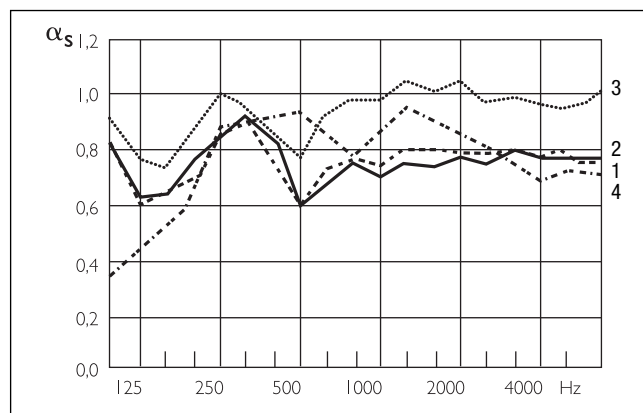

300C

$\alpha_s$  = sound absorption degree:  
an absorption of 1.0 indicates a 100% absorption of sound.

### - Curve 1 $\alpha_s$ 300C

$\varnothing$  2.0 mm perforated panels, provided with 0.2 mm thick, black non-woven acoustic tissue glued over the whole perforated area. Plenum depth is 400 mm.

### - Curve 2 $\alpha_s$ 300C

$\varnothing$  1.5 mm perforated panels, provided with 0.2 mm thick, black non-woven acoustic tissue glued over the whole perforated area. Plenum depth is 400 mm.

### - Curve 3 $\alpha_s$ 300C

$\varnothing$  1.5 mm perforated panels, provided with 0.2 mm thick, black non-woven acoustic tissue glued over the whole perforated area plus 25 mm thick mineral wool pad with a density of 16 kg/m<sup>3</sup>. Plenum depth is 400 mm.

### - Curve 4 $\alpha_s$ 300C

$\varnothing$  2.0 mm perforated 300C panels, provided 25 mm thick mineral wool pad with a density of 22 kg/m<sup>3</sup> wrapped in polyethene foil. Plenum depth is 400 mm.

Freq. Hz.	125	250	500	1000	2000	4000	$\alpha_w$
Curve 1	0.61	0.85	0.59	0.75	0.78	0.76	0.75(L)
Curve 2	0.62	0.82	0.60	0.70	0.78	0.77	0.75(L)
Curve 3	0.76	0.99	0.75	0.97	1.05	0.95	-
Curve 4	0.42	0.85	0.93	0.83	0.84	0.69	-

*The 300C Wide Panel ceilings were tested by TNO Delft (The Netherlands), an independent official testing institute. Report no.: TPD-HAG-RPT-94-0037*

*300L panel due to shape similar performance as 300C panel.*

# 84R Curved

## PANELS

The 84R ceiling system consists of round-edged panels (1) which can be easily clipped on a carrier (2). The panels can be joined with the panel splice or by clipping the panels over each other. Curved 84R ceilings can be created by using a flexible carrier or curving the panels (1).

## SUSPENSION

The panel carrier (2) is provided with prongs to accommodate the panels in a standard module of 100 mm. All carriers have a standard length of 5000 mm, and are connected by the carrier splice (5). A nonius hanger (3) and fixing pieces (4) are provided for suspension.

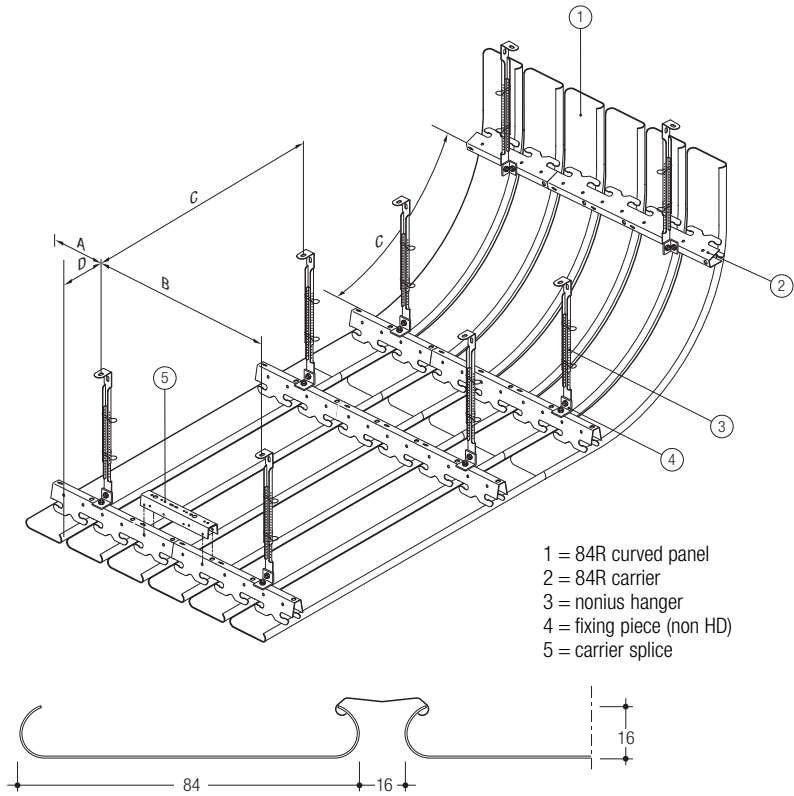

## MAXIMUM SPANS

\* Minus 200 mm in case of acoustic pads.

Panel type	Carrier span (mm)		Panel span (mm)			
	A	B	on 2 carriers		on 3 or more carriers	
			C*	D	C*	D
84R	300	1700	1500	150	1700	150

## DIMENSIONS & WEIGHTS

\* Based on panels installed on 3 or more carriers.

The panels are made to measure in any length from 800 mm up to 6000 mm.

Panels > 6000 mm available on request.

Panel	Width (mm)	Module (mm)	Min. length (mm)	Max. length (mm)	Weight panels & carriers/m <sup>2</sup> *			
					Steel carrier		Alu carrier	
					Excl joints	Incl joints	Excl joints	Incl joints
84R	84	100	800	6000	1.8 kg	2.3 kg	1.7 kg	2.2 kg

## MATERIAL REQUIREMENT PER M<sup>2</sup>

The required number of components depend on individual project requirements. Figures are based on maximum spans.

	Unit	Linear 84R system
Panels	lm	10
Join profiles	lm	10
Carriers	lm	0.59
Carrier splice	pc	0.12
Suspension	pc	0.35

## FIXED AND VARIABLE

Curved panels help create concave, convex or undulating ceilings with a fixed radius of 325 mm, or a variable minimum radius of 1250 mm, achieving dramatic visual effects while also accommodating varying heights. Panel angles can vary between 0 degrees (flat panel) and 90 degrees.

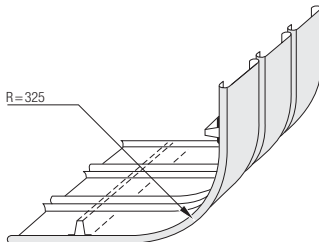

Outside corner (fixed radius)

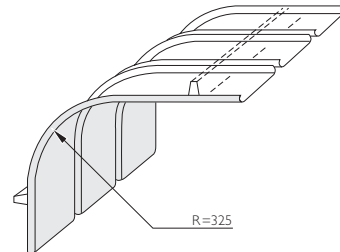

Inside corner (fixed radius)

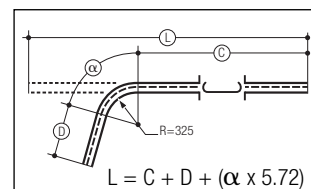
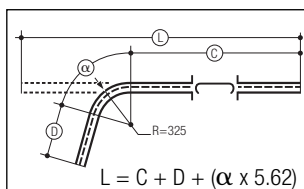



# 84R Curved

## AVAILABLE CURVED PANEL TYPES

Standard minimum radius for all curves approx. 1250 mm (exterior 1000 mm).

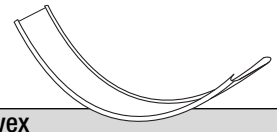
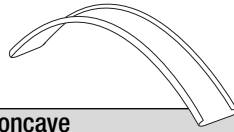

Type of Curve	Concave	Convex
Continuous curve		
Curve + straight end(s) C + D		

## APPEARANCE

- A linear, open ceiling surface using a concealed carrier suspension system allows the chosen panel curve to determine the appearance of the ceiling.
- The easy panel-on-carrier suspension system, the same as in the standard 84R ceilings, allows for easy transition to straight ceilings using the same panel.
- Long and narrow panel ceilings, length made to measure up to 6000 mm, allow swift installation (especially in larger areas) and reduce the needs for joints to a minimum.

I: Multiple panel curved ceilings:



II: Single panel curved ceilings:

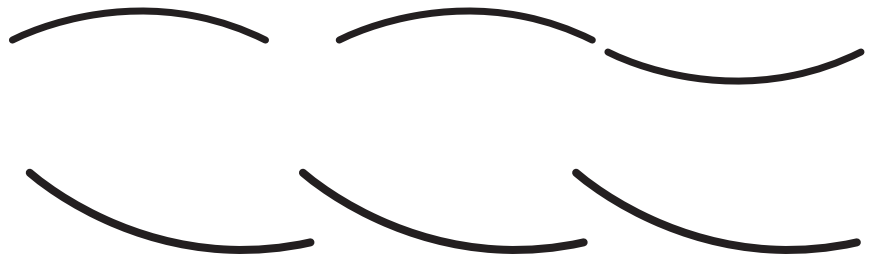

## VALUES

\* Curved panels feature straight ends of min. 130 mm.

Legend	Min/Max Values
L = Length of straight panel	Lmin = 1 mtr (std)
	Lmax = 6 mtr (std)
C/D = Length of straight ends	C/Dmin = 200 mm
R = Radius	Rmin = 1250 mm (interior)
	Rmin = 1000 mm (exterior)
α = Angle (alpha degrees)	αmax = 90°

# Acoustics 84R Curved

## ACOUSTIC PERFORMANCE

In order to improve interior sound control, Luxalon® 84R Ceiling panels can be perforated with a  $\varnothing$  of 1.0 or 2.0 mm (open area of 15% and 23%). A sound-absorbing non-woven tissue comes standard with perforated panels for enhanced acoustical performance. To further increase acoustic absorption, consider the ceiling radius: an increase in material surface quantity can result in up to 55% enhancement of absorption surface.

## PERFORATION OPTIONS

84R panels are available in 2 standard perforation patterns:

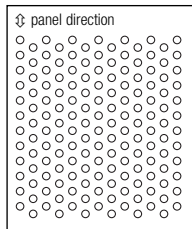

Ø 1 mm  
23% open area  
⇄ 2 ⇄ 3.46

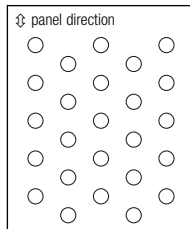

Ø 2.0 mm  
15% open area  
Δ 5 mm

## 84R

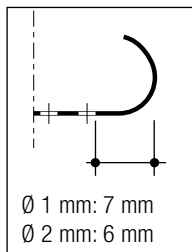

*Note: Panels have a plain border along their length to insure that the panel is flat and to enhance its strength.*

Project : Bathydang, Keleti station, Astorid  
Location : Budapest, Hungary  
Product : Curved Ceiling 300C

## SOUND ABSORPTION DATA 84R (straight panel)

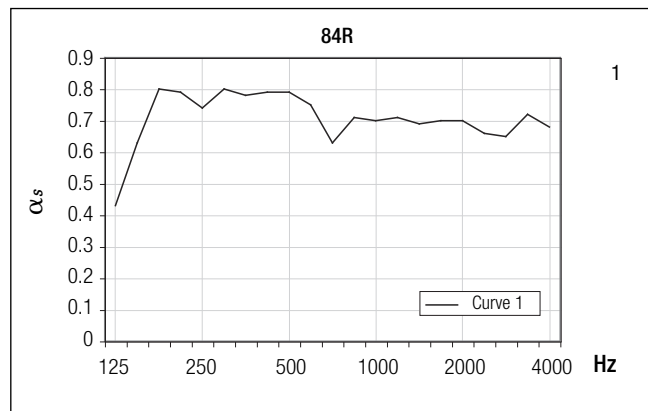

84R

$\alpha_s$  = sound absorption degree:  
an absorption of 1.0 indicates a 100% absorption of sound.

### - Curve 1 $\alpha_s$ 84R

84R panels with  $\varnothing 2$  mm holes, module 100 mm, closed joints. The reverse side of the panels is provided with black non-woven tissue glued over the whole perforated area. Plenum depth is 200 mm.

Freq. Hz.	125	250	500	1000	2000	4000	$\alpha_w$	NRC
Curve 1	0.43	0.74	0.79	0.70	0.70	0.68	0.75(L)	0.75

Tested by Peutz; test report no: A1709



# Curved Carrier

## PRINCIPLE

Consider a different and dramatic design - a curved ceiling with straight panels. This ceiling is possible when you use the Multi Panel system and the panel systems 84B, 84R, 70U and 300C.

## BENEFITS

- A standard product and production process creates an extremely cost effective curved metal ceiling solution.
- Curved carriers support concave, convex or undulating ceilings, creating dramatic visual effects while accommodating varying heights.
- Long and narrow or Wide panel ceilings are made to measure up to 6000 mm, which allows for swift installation (especially in larger areas) and reduces the need for joints to a minimum.
- The same easy panel-on-carrier suspension system as used on standard ceilings, allowing easy transition to straight ceilings using the same panel.

## 1. PRINCIPLE SEGMENTED CARRIERS

Luxalon® Wide Panel ceiling 300C

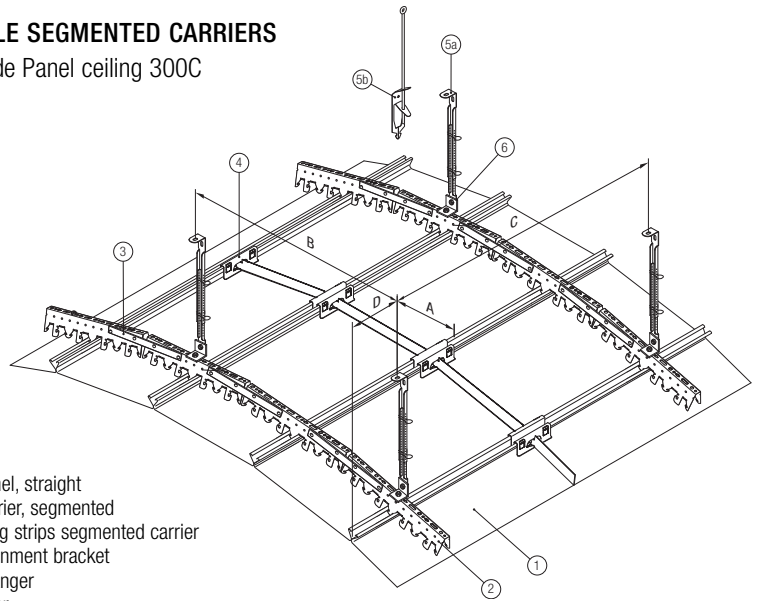

- 1 = 300C panel, straight
- 2 = 300C carrier, segmented
- 3 = connecting strips segmented carrier
- 4 = 300C alignment bracket
- 5a = nonius hanger
- 5b = rod hanger
- 6 = fixing piece (non HD)

	Min. radius concave (m)	Min. radius convex (m)
Segmented carrier	2	5

## 2. PRINCIPLE FLEXIBLE CARRIERS

Luxalon® Linear ceiling system 84B, 84R, 70U and Multi panel

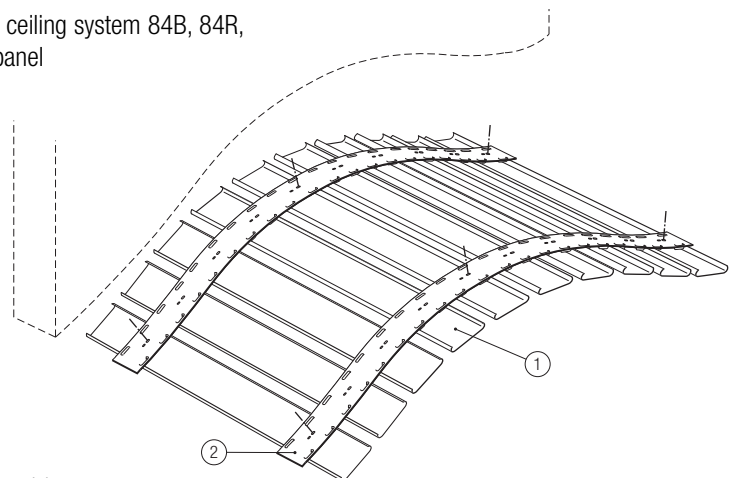

- 1 = ceiling panel, straight
- 2 = flex carrier

	Type of ceiling	Minimum radius profiles	Flat recessed join profile	V-20 join profile
		Min. radius (mm)	Min. radius (mm)	Min. radius (mm)
Convex	80B	300	450	300
	130B	1,200	1,200	1,200
	180B	600	600	600
	84B	600	Not applicable	Not applicable
	70U	600	Not applicable	Not applicable
Concave	80B	400	600	600
	130B	600	2,000	600
	180B	1,200	5,000	1,200
	84B	400	Not applicable	Not applicable
	70U	200	Not applicable	Not applicable

# Material specifications

## - Proven Fire Protection

Luxalon® metal suspended ceilings are classified incombustible and will therefore not contribute to possible fires. When ceilings need to protect the structural integrity of the building, Luxalon® ceilings offer a range of practical and tested solutions with regards to fire resistance and fire stability.



## - ENVIRONMENT

Hunter Douglas is dedicated to manufacturing sustainable products. Our paint and aluminium melting processes are considered industry standards in terms of clean production processes. All of our aluminium products are 100% recyclable at the end of their lifecycle.

*Right : Railway station Berchem  
Location : Antwerpen, Belgium  
Product : Curved ceiling 84R Exterior*

Unprecedented Protection  
**LUXACOTE®**  
for exterior application

## - EXTERIOR USE

Luxalon® Curved ceilings are ideal for outdoor applications. Our proprietary coil-coating process ensures a strong finish - the Luxacote® system. Luxacote® contains a solid UV filter that guarantees colour-fastness and gloss stability as well as optimal resistance against corrosion, abrasions and scratches.

## - Colour range

The standard Hunter Douglas interior and exterior colour range for Luxalon® Ceiling systems includes a wide variety of colours and finishes. See the Luxalon® colour chart for all available options. All RAL and NCS colours are also available on request.

## - Tolerances

As a member of the Technical Association of Industrial Metal Ceiling Manufacturers (TAIM), Hunter Douglas complies with tolerance criteria as specified in chapter 4 of the TAIM Quality standards for metal.

## CURVED CEILING POSSIBILITIES

Curved panels: 84R, 300C

Segmented carriers: 300C

Flexible carriers: Multipanel, 84B, 84R, 70U

## LUXALON® EXTERIOR CEILINGS



Luxalon® Exterior ceilings are developed to withstand all weather influences including intensive sunshine, dramatic temperature changes, moisture, pollution, and strong wind loads. Their durability comes from our special aluminium alloy, and the patented Luxacote® system. Luxalon® Exterior ceilings are ideal for use in canopies, shopping centres and railway/underground stations.

- Special alloy of corrosion-resistant aluminium
- Luxacote® coating system resistant to UV, scratches and vandalism and is rain-, dirt- and snow-proof
- Certified for wind loads

# Impressions

## **CURVED PANELS**

*Right : Nanji airport  
Location : Nanji, Japan  
Product : Curved ceiling 300C*

*Below : Metro Valencia Estacion Santa Rosa  
Location : Valencia, Venezuela  
Product : Curved ceiling 300C*



## **CURVED CARRIERS**

*Right : O.L.V. van Lourdes College  
Location : Edegem, Belgium  
Product : Linear ceilings 70U*

*Below : Underground Station  
Location : Rotterdam, the Netherlands  
Product : Wide Panel ceiling 300C*



## HUNTER DOUGLAS ARCHITECTURAL PRODUCTS

In the last 80 years, we've been fortunate enough to help turn countless innovative sketches into innovative buildings.



Architects, designers, investors, and contractors from around the world have taken advantage of Hunter Douglas' unmatched product development, service, and support. Chances are, you've seen more of Hunter Douglas than you think.

With major operation centres in Europe, North America, Latin America, Asia, and Australia, we've contributed to thousands of high-profile projects, from retail and commercial facilities to major transit centres and government buildings.

Not only are the world's architects and designers our partners, they're our inspiration. They continue to raise the bar for excellence. We create products that help bring their visions to life: Window Coverings, Ceilings, Sun Control Systems, and Façades.



Promoting sustainable  
forest management  
[www.pefc.org](http://www.pefc.org)

© Registered trademark - a HunterDouglas® product Pats. & Pats. Pend. - Technical data subject to change without notice.  
© Copyright Hunter Douglas 2009. No rights can be derived from copy, text pertaining to illustrations or samples. Subject to changes in materials, parts, compositions, designs, versions, colours etc., even without notice. **MX200C000**

## ARCHITECTURAL SERVICES

We support our business partners with a wide range of technical consulting and support services for architects, developers, and installers. We assist architects and developers with recommendations regarding materials, shapes, dimensions, colours, and finishes. We also help creating design proposals, visualizations, and mounted drawings. Our services to installers range from providing detailed installation drawings and instructions to training installers and advising on the building site.



**LUXALON®**

**HunterDouglas**

**HUNTER DOUGLAS** is a publicly traded company with activities in more than 100 countries with over 150 companies.

The origin of our company goes back to 1919, in Düsseldorf, Germany. Throughout our history, we have introduced innovations that have shaped the industry, from the invention of the continuous aluminium caster, to the creation of the first aluminium Venetian Blinds, to the development of the latest high quality building products.

Today we employ more than 20,000 people in our companies with major operation centres in Europe, North America, Latin America, Asia, and Australia.

**Innovative Products  
Make Innovative Projects**

# Learn More

- Contact our Sales office
- [www.hunterdouglascontract.com](http://www.hunterdouglascontract.com)

Wide Panel

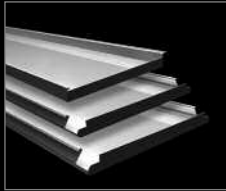

Linear

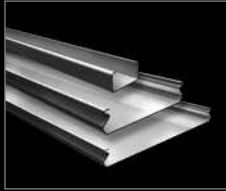

Screen



Tiles  
XL panel



Cell  
Stretch metal

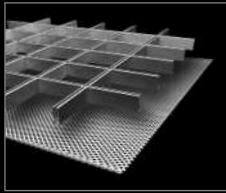

Chilled  
Curved



Exterior



- Austria
- Belgium
- Bulgaria
- Croatia / Slovenia
- Czechia
- Denmark
- France
- Germany
- Greece
- Hungary
- Ireland
- Italy
- Kazakhstan
- the Netherlands
- Norway
- Poland
- Portugal
- Romania
- Russia
- Serbia
- Slovakia
- Spain
- Sweden
- Switzerland
- Turkey
- Ukraine
- United Kingdom
- Africa
- Middle East

- Asia
- Australia
- Latin America
- North America

**HUNTER DOUGLAS EUROPE B.V.**  
 2, Piekstraat  
 P.O. Box 5072 - 3008 AB Rotterdam  
 Tel. +31 (0)10 - 4869911  
 Fax +31 (0)10 - 4847910  
[www.hunterdouglascontract.com](http://www.hunterdouglascontract.com)

# HunterDouglas